

# ENGINEERING

TEACHING. RESEARCH. ENTREPRENEURSHIP. ENGINEERING WITH IMPACT.  
16 | SPRING 2022



DALHOUSIE  
UNIVERSITY

FACULTY OF ENGINEERING

## BUILDING THE MODERN ENGINEER

# ENGINEERING



## PROFILES

MEET OUR UP-  
AND-COMING  
RESEARCHERS

2

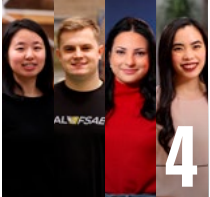

## FEATURE

THE MODERN  
ENGINEER

4



## FEATURE

IMPROVING THE  
HEALTH OF ASTHMA  
PATIENTS

10

**12 ENTREPRENEURSHIP & INNOVATION**  
GOING CLEAN AND GREEN

**20 FACULTY NEWS**  
DR. JANIE WILSON OPENS  
NEW DOORS IN BIOMEDICAL  
ENGINEERING

**24 ALUMNI PROFILE**  
REMEMBERING THE GREAT  
PEARL SULLIVAN

## CONTRIBUTORS

### EDITORIAL

Theresa Anne Salah, Marilyn Layne,  
Mark Campbell, Jennifer Cameron

**PHOTOGRAPHY** Nick Pearce

**DESIGN** Erin Lee

**CONTACT** Theresa Anne Salah,  
Editor, [tasalah@dal.ca](mailto:tasalah@dal.ca)

 @DalhousieEngineering

 @DalEngineering

 DalhousieEngineering

 Dalfacultyofeng



## Dean's Message

**GREETINGS TO OUR ENGINEERING COMMUNITY.** It's been just over nine months since the release of our last Engineering Magazine, and we have a lot of great news to share.

The Faculty of Engineering is pleased to announce the upcoming launch of its new strategic plan. Since September of 2021, we have been developing our plan in consultation with a diverse group of stakeholders including faculty members, leadership, students and community partners. The plan maps a new direction and vision in engineering education.

The plan takes a forward thinking approach with an emphasis on building the "Modern Engineer." The Modern engineer is a theme you will see throughout this issue of the magazine.

Today's students are driven by the power of technology and a stronger awareness of the global challenges we face, including health, equity, economic growth and climate. Our students are looking for careers where they can make a positive impact on our community, and companies are seeking engineers who possess the desire for innovation, creativity, interdisciplinary efforts, and the confidence to take on bold projects and become bold leaders.

While the Faculty of Engineering will continue to teach and train the traditional technical competency of an engineer, we are also investing in professional skill development, experiential learning opportunities and industry experts to coach and mentor students to be future leaders and innovators of tomorrow. These enhancements will lead to engineers with the capability and power to positively change our world.

In this issue of our spring magazine you will meet a variety of students and young alumni who are destined for future success. These engineers are developing key skills and experiences through participation on our student design teams, academic programs, opportunities available in our Emera ideaHUB, and key research work within the faculty. We are proud to call these students and alumni our "modern engineers."

We hope you enjoy the 2022 issue of Engineering, and we look forward to sharing our full strategic plan with you soon.

Sincerely,

**Dr. John Newhook, P. Eng., FCAE**  
Dean, Faculty of Engineering

**2005**

UNDERGRAD  
STUDENTS

**575**

GRADUATE  
STUDENTS

**2580**

TOTAL  
ENROLLMENT

**23%**

FEMALE  
UNDERGRADS

**77%**

MALE  
UNDERGRADS



**30%**

FEMALE GRAD  
STUDENTS

**69%**

MALE GRAD  
STUDENTS

**61%**

CANADIAN

**119**

FACULTY

**18,589**

ALUMNI

**39%**

INTERNATIONAL

**97%**

CO-OP  
PLACEMENTS

**580** SEXTON  
SCHOLARS

**37** SEXTON  
LEADERS

**41%**

FROM  
NOVA SCOTIA

**632**

UNDERGRADUATE  
SCHOLARSHIPS

**60**

UNDERGRADUATE  
BURSARIES

**12**

RESEARCH  
CHAIRS



# Helping Communities Prepare for Natural Disasters



## AS THE WORLD GRAPPLED WITH

how to manage a once-in-a-lifetime pandemic, Dalhousie University Industrial engineering graduate students Laurayne Rodrigues and Luana Almeida dedicated themselves to helping us prepare for another potential crisis.

“We have research indicating there will be a major earthquake within the next 500 years on Canada’s west coast,” says Rodrigues. “That will have a significant impact on marine transportation systems and the communities that rely on them in British Columbia. We wanted to better understand the vulnerabilities in the systems so that decision-makers can be better prepared.”

Collaborating with Dalhousie faculty and researchers, Almeida and Rodrigues developed detailed models and analyses of potential earthquake activity and infrastructure damage for Shipping Resilience: Strategic Planning for Coastal Community Resilience to Marine Transportation Risk (SIREN). Funded by Emergency Management British Columbia and the Marine Environmental Observation, Prediction and Response Network (MEOPAR), the project’s objective is to assess the potential damage to marine transportation systems from natural hazard events to help authorities to prepare for the risk.

“We were not trying to predict what the emergency response should be,” Almeida explains. “We were trying to project which roads, ports, and ships are likely to be damaged or remain intact and how could those projections be used to maintain supplies to affected communities.”

Over the course of the project, Rodrigues conducted data collection and analysis of Vancouver Island-related

shipping routes to assess the potential for ship damage and interruptions. Almeida drew on that research to develop a logistics and multimodal transportation model that identified communities that might be cut off from relief supplies. Through workshops, they shared progress with stakeholders and used feedback to expand and refine their efforts, such as considering the impact of an earthquake and tsunami on the Gulf Islands.

**“WE WANTED TO BETTER UNDERSTAND THE VULNERABILITIES IN THE SYSTEMS SO THAT DECISION-MAKERS CAN BE BETTER PREPARED.”**

— LAURYNE RODRIGUES

“It’s a model so it cannot capture all the variables and everything that could happen, but I am trying to make it as realistic as possible so stakeholders and decision-makers have the insights they need to be prepared for a natural disaster,” Almeida says.

One insight that emerged from their work was the realization that barges will likely play a key role in the distribution of relief supplies. “Barges are flexible assets in that they do not require the port infrastructure that many ships or ferries require to deliver goods,” Almeida says. “However, Laurayne’s research suggests that barges are likely to see more damage than larger vessels, but

those larger vessels could take a couple of days to a couple of weeks to start moving efficiently again.”

“This was quite an undertaking for Luana and Laurayne not just because they did most of the work on this project but also because they had to learn what data was available and apply methodologies to gathering and assessment that were not taught in class,” says Faculty of Engineering Professor Dr. Floris Goerlandt, the Canada Research Chair in Risk Management and Resource Optimization for Marine Industries.

“They also faced the added challenges of communicating with stakeholders online and working remotely due to the pandemic, which was not easy given the scale of an undertaking like this. The way that they persisted and completed the work was admirable.”

Now that the project has wrapped, Goerlandt and Dr. Ronald Pelot, a professor in the Department of Industrial Engineering, are developing a book that will summarize the findings and how they can be applied to address similar challenges. For Almeida and Rodrigues, SIREN created invaluable opportunities to connect with other academics, apply their learning, and work with a range of stakeholders to achieve a collective goal.

“It was really good to see those interactions and different views on how to solve problems,” Rodrigues says. “But it was also a great experience in that I got to work with a lot of data analysis and science and that is something I would like to continue doing.”

# Dalhousie Researchers Set to Make a Big Impact on our Water

Fresh, clean water is vital to all life on earth. But human activity, and climate change related to that activity, poses significant threats to this vital resource. Dalhousie engineering researchers are addressing this challenge through innovative new initiatives.



**DR. ALISON SCOTT** is exploring the potential of customized polymer design to facilitate water treatment. Her work involves synthesizing small batches of polymers to better understand the design process and thus the structure, properties, and performance of the resulting polymer chain to assess its efficacy for different treatment applications. She is particularly interested in multicomponent polymers—chains with different repeating units.

“These different units impart different properties to the polymer,” says Scott, an Assistant Professor with the Department of Process Engineering and Applied Science. “For water treatment, one aspect we are focused on is incorporating monomers with different charges to understand how they incorporate into the chain. If we have a formula that has 50 percent of one monomer and 50 percent of a second one, the reactivity of the two is often not

the same. We might see one monomer is incorporated more readily than the other. By figuring out how to better control the incorporation of those components, we can predict and manipulate the structure of the resulting polymer.”

Understanding that will facilitate the development of polymers that target specific contaminants in drinking water, municipal wastewater, or wastewater from industrial processes such as mining. The work is still early stages, but Scott is already thinking about other applications, such as hydrogels—a mesh approach to polymer design that could have absorbency applications in a range of industries from agriculture to diaper manufacturing, and biobased polymers that could replace synthetic ones.

Meanwhile, **DR. LAUREN SOMERS** is exploring hydrological systems—how they function, how climate change and human actions can impact them, and how to improve the functionality of these systems from an adaptation and mitigation standpoint. One research project will explore the role of wetlands in recharging or storing groundwater in the Cape Breton Highlands. Somers will install hydrologic monitoring equipment at selected wetlands to assess factors

such as streamflow and water levels in wetlands and, potentially, deep groundwater wells.

“We are looking at which landscapes are most important for sustaining streamflow or feeding community wells,” says Somers, a professor in the Department of Civil and Resource Engineering.

“Eskasoni, Ingonish, Baddeck, Cheticamp—they all get their water supply from groundwater that comes from Highlands or the foothills. Through this research, we hope to discover where that water comes from and the extent to which the quality and quantity may change as the mountain climate shifts.”

Somers is also collaborating with Department of Civil and Resource Engineering colleagues Dr. Barrett Kurlyk and Dr. Rob Jamieson on research involving the consequences of agricultural-related coastal nitrogen pollution on water systems in Tatamagouche and PEI’s Basin Head Provincial Park. Somers will assess salt marsh ecosystems. Through efforts such as this, she hopes to enhance our ability to mitigate or adapt to changes in our water system from climate change and human impacts.





# BUILDING THE MODERN ENGINEER

At first glance, it may seem like the role of the engineer hasn't changed over the years, and in many respects, this is true. At their core, engineers will always be critical thinkers and problem solvers. But as our society rapidly evolves, so has the role and the face of the modern engineer.

Technology has played a huge part in this change. Today's engineering students are entering post-secondary education with a world of knowledge at their fingertips and stronger global interconnections influencing their career decisions.

Over the years, Dalhousie's Faculty of Engineering has made a concerted effort to train the modern engineer. This includes introducing new programs and opportunities into their curriculum. The campus is now filled with students poised to have a big impact on society. But who are these future engineers, and how will they change our lives?

Meet four students who are defining the role of the modern engineer.





# Designing Sustainable Solutions to Global Challenges

## IF YOU ASK 4TH YEAR

electrical engineering student Gina Park why she created Dalhousie's first solar car team, she'll list several reasons why the initiative has had a remarkable impact on her educational journey.

From multi-disciplined experiential learning to project management, Park says building a raceable car takes more than technical skills. She adds that many people fail to realize that the project is more than just the experience of building a vehicle to race in a competition.

"Look at the conflict in Ukraine and the effect on gas prices. More and more people are made aware of our dependence on non-renewable sources and are adopting to sustainable ways of living life," she says. "All the problems that are happening in the world are going to come to us and we will need to solve them. Solar car is our take on what we are going to do about it. We want to leave a legacy that adds value to the planet and to us."

With an increased interest in sustainable energy systems, solar cars could change the future of transportation and the automotive industry. Park felt inspired to start

Dalhousie's Solar Race team after learning more about the project from other solar car team alumni across North America. Now she and thirty other engineering students at Dal are in the process of building a solar vehicle for the Formula Sun Grand Prix 2022 in July. The collegiate competition is open to teams from around the world.

"I wanted to work on an extremely hands-on project that is focused on renewable energy," she says. "There is a huge network of brilliant minds within the solar car community. It was also the spirit of sportsmanship and teamwork I've observed within this community that encouraged me to start the team."

The group has now started creating a new battery pack, reconfiguring the solar array, developing a new electrical power system and making several major mechanical upgrades on the body of a retired vehicle they acquired from an American team. Park says it typically takes two years to build a solar car from scratch, but with limited time this year, her team will revamp the solar car body to meet regulations for this year's competition.



Next fall, the team will begin work on designing and creating a brand-new solar car from the ground up. Park hopes the team will compete in the 2025 World Solar Challenge.

"I want my team to start and lead conversations about sustainable transportation in Atlantic Canada," she says. "The foundation on which I want to build this team is grit and willingness to learn. Such qualities teach us a wide set of skills to use in our engineering careers."



# Engineering with Leadership

## FOR MITCH GREGORY'S THIRD

co-op term, the 5th year mechanical engineering student saw a unique opportunity for his career growth. Instead of accepting a position with a company in the mechanical engineering field, he decided to pursue an entrepreneurial placement of his own. He created and launched his own start-up, Mavio Technologies. The new venture focused on developing clean technology solutions and applying them to today's real world problems.

Since starting his engineering degree at Dal in 2017, Gregory's educational journey has been driven by his interest in renewable energy technologies. Joining Dalhousie's Formula SAE (FSAE) team in his third year of studies, he pushed the team to move from an internal combustion engine car to an electric powered vehicle.

The team, which provides students with the opportunity to design, build and race an open-wheeled race car for competition in the Formula Student Collegiate Competition, has built ten gas-powered vehicles since 2007. For

Gregory, it was time to lead them in a new direction.

"If you connect the dots between what we need from a sustainable society and what we are developing here, there are direct linkages. If you do that with a gas car, there's a disconnect," he says. "Building battery systems and building electric vehicles, whether it's big or small is a skill set that's applicable to a future career in many different industries."

Now captain of Dal's FSAE team, Gregory is leading the design and development of the University's first electric powered vehicle sponsored by Emera. Gregory says he hopes to have the car ready for competition in 2023.

Partnerships are key to successful innovations, and with a generous sponsorship from Emera, the team now has the ability to add an electric motor to their vehicle. Throughout the years, Emera has continued to empower the next generation of engineers at Dal through the Emera ideaHUB.

"I think industry supports this because it's what we need to see," says Gregory. "There are so many different opportunities for collaboration because there are so many different areas of an electric vehicle development that are relatable to areas that are being rapidly developed."

Gregory says he hopes to have the electric vehicle ready for testing this



fall. Down the road, he is also hoping to push his ambitions one step further, developing stronger partnerships with external companies, and collaborating on initiatives that will positively impact the growth of his teammates.

"One thing that I would love to do is work with industry to test their innovative technologies. There are a lot of companies who have motors for example that they're testing, and what I think we could do is to collaborate with industry to test their systems and help develop them further."

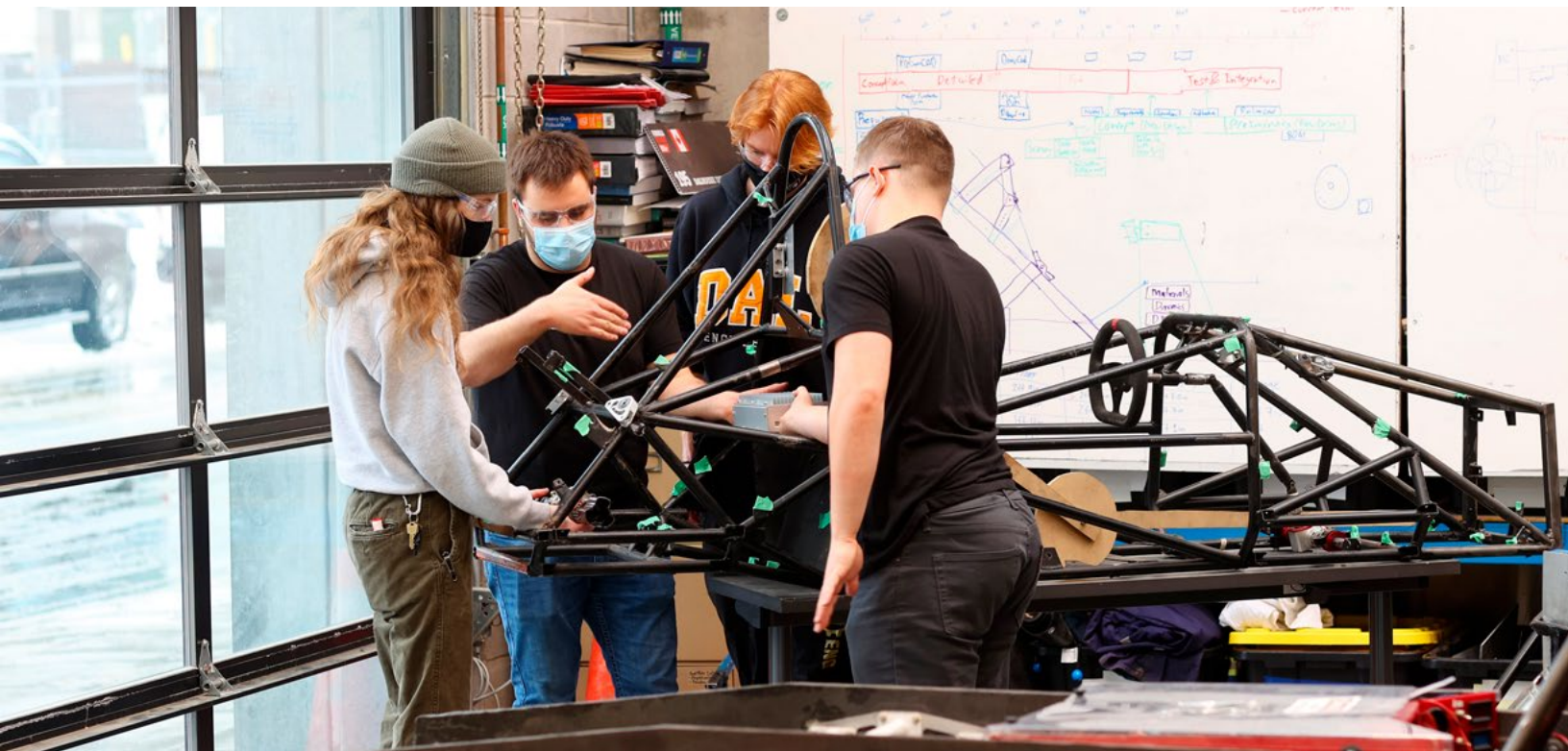

# Taking on Bold Projects

## KATERINA VINOGRADOVA HAS

always been fascinated in the space sector, but as a chemical engineering student, she wasn't sure how to connect her skillset with the right opportunities in Atlantic Canada. When she learned about the Faculty of Engineering's Dalhousie Space Systems Labs (DSS), she jumped at the chance to join the student team.

DSS primarily focuses on the research and development of small satellites called CubeSats. These are square, miniature satellites that perform specific tasks in the Earth's orbit. The team's original satellite, known as the LORIS project, will be the first satellite fully designed in Nova Scotia. Recently however, the student team has taken on a number of bold new initiatives including the design and creation of a rocket.

"Neither me nor my other teammates have any experience designing a rocket, building a rocket or testing a rocket," says Vinogradova. But that hasn't stopped the 3rd year chemical

engineering student from taking the lead on the project. She and her teammates are now participating in the Launch Canada Challenge. This will be the first time a rocket has been designed in the Atlantic Canada region.

The Launch Canada Challenge provides post-secondary students with the opportunity to build their expertise and interact with the larger rocketry community. Teams are required to build and launch a solid rocket motor to an altitude of 10,000 feet. While some teams build sophisticated vehicles using large off-the-shelf rocket motors, others teams develop their own hybrid and liquid rocket engines.

Although this year Vinogradova says she and her teammates will use solid-fuel to propel their rocket, she feels a sense of exhilaration thinking of the possibilities for the future.

"One of the reasons I wanted to start rocketry is because I have a specific interest in propulsion and fuel," she says. "My hope is that within the next couple of years the team will have designed and built a hybrid fuel engine instead of using an off the shelf solid motor."

Since their launch in 2017, DSS has been working to make Nova Scotia a hub for space exploration in the province. Their hope is to retain students interested in a career in the space

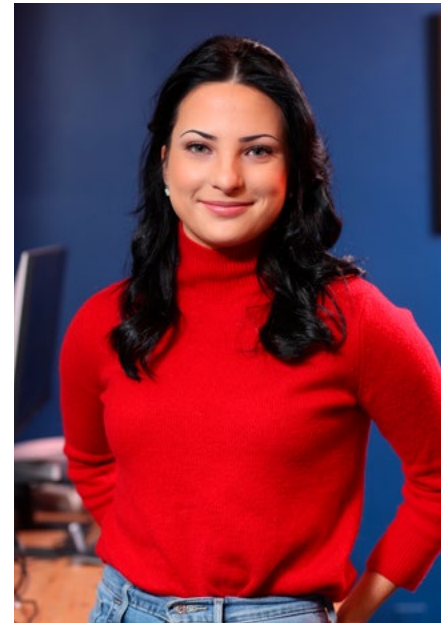

industry. Vinogradova says without the team, she may not have found the right path.

"I was always interested in the space sector and I didn't know how to get into the industry and get exposure. This has 100 percent made me want to work in the industry. I've figured out what I don't like and what I do like within the sector, and the avenue I want to take is propulsion, developing liquid fuel and hybrid fuel."

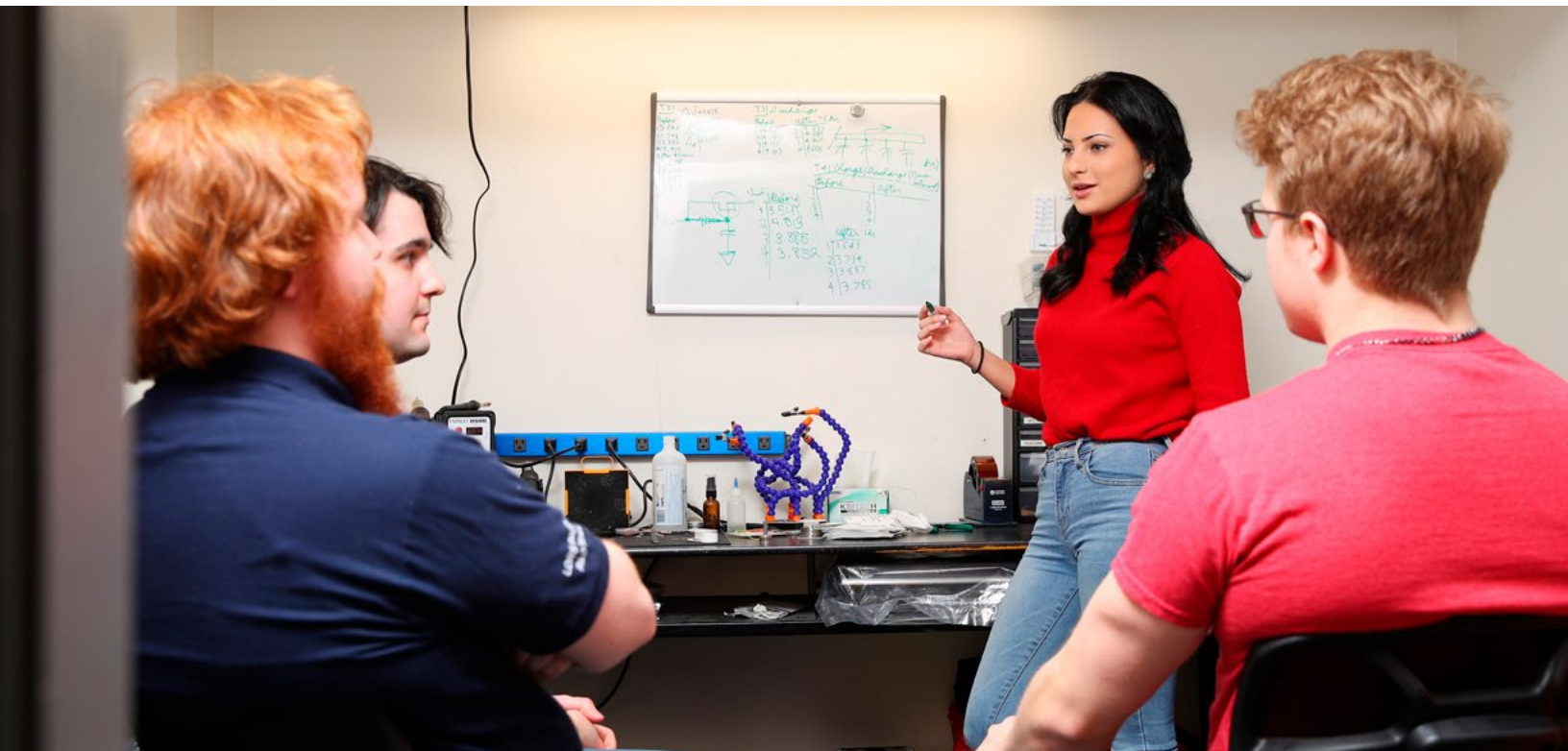





# Understanding the Value of Interdisciplinary Work

## DALHOUSIE ELECTRICAL

engineering student Jade Farr loves talking about the Dalhousie Microtransat Autonomous Sailboat. And she should. Once a Faculty led project, the team is now driven by student leaders from every discipline on the engineering campus. “When you look at where we started and where we are now, there is so much growth within the past two years. We’ve rebuilt this group from the ground up,” she says.

The student design team is a continuation of a project originally overseen by the Faculty of Engineering. Their famous sailboat, the SeaLeon, set a record for the longest distance travelled by unmanned marine technology in 2018. Since then, the project has been taken over by Farr and a team of over fifty students on campus. Together they’ve been analysing the previous vessel, and working to design and create a new and improved sustainable, small-scale, autonomous sailboat. The project is part of an international competition known as the Microtransat Challenge, which tasks

teams to build self-driving marine vessels capable of crossing the Atlantic Ocean.

When Covid-19 hit in March of 2020 there were only six students remaining on the sailboat team, Farr included. Understanding the significant impact interdisciplinary collaborations would have on the success of their project, Farr has spent the last two years working to recruit a wide-range of students to the team.

“When you go into classes you are only with your own discipline, you only do projects with students in your discipline, but that’s not the real world,” she says. “In the real world, you’re working with different people who have different backgrounds, and you’re working together on a common goal.”

The team is now divided into four sub groups: Management, Electrical, Software and Mechanical. In addition to engineering students, Farr has also recruited students from the Faculty of Management and Computer Science. Together, they have raised around \$10,000 for the project, and are gearing up to set sail off the shore of Cape Breton this fall. Their autonomous sailboat is equipped with a number of new features this year including two 40W flexible solar panels.

“Depending on how many batteries we are using for the sailboat, the solar panels may provide the extra push in energy required to make the entire trip. If not, they are just an added bonus,” explains Farr.



She adds that as a leader, she has a lot of trust in the team around her and has worked to build the team as a family. She says she’s amazed at how many students have joined and remained on the sailboat team over the last two years and commends her other team leads for their hard work.

“We’re really lucky to have this many students who want to work with us and contribute to the project. And that’s why I joined the team. You get the experience of working in a team and combining all of those people together to finish your one goal.”



# DALHOUSIE COUPLE HELP CHILDREN WITH ASTHMA BREATHE EASIER

“OUR GOAL AT HOLLO IS TO HELP BRING THIS SOLUTION TO PEOPLE IN NEED, BUT ONE OF MY PERSONAL GOALS IS TO INSPIRE WOMEN IN STEM.”

— SARA FEDULLO

## SARA FEDULLO (BENG'21)

didn't want to be a small ant in a big ant farm. She wanted to stand out and make an impact on society. Her gateway to do that: her engineering degree.

When her partner, Dal medical student David Hodgson, came home one evening with the idea to create a solution that would help children with asthma more effectively administer their medication, the Dal chemical engineering grad was inspired.

She says that when children use their asthma inhaler (also known as the common puffer), there's a 90 percent chance that they aren't doing it correctly. That's because the pressurized inhalers release the medicine too quickly, making it difficult for children to coordinate inhaling their medication. As a result, much of the drug is deposited to the back of the throat and swallowed, increasing the risk of side effects and minimizing the intended relief.

Spacers are traditionally used by people of all ages to improve an inhaler's performance. They attach to the inhaler and act as holding chambers for the medication. The medication is dispensed and then suspended in the spacer's chamber. This gives the user more time to breathe normally so the lungs absorb

the dose of medicine slower and more smoothly.

“Spacers tend to be very bulky, they are the size of a water bottle, but they're also very essential,” says Fedullo. “Unfortunately because of how big these spacers are, people don't use them as much as they should.”

Interviewing respiratory therapists, allergists, people with asthma, and the parents of children with asthma, Fedullo and Hodgson discovered that many children felt embarrassed carrying around their bulky spacers, leading to missed doses when they need them most.

In the summer of 2021, Fedullo and Hodgson launched their start-up HOLLO Medical and turned to Dal's Emera ideaHUB which helps ventures accelerate the development of innovative physical-products. The pair are now working on a pocket-sized spacer that's portable, effective, easy to use and easy to clean.

“This is not as simple as just making something portable. You also have to think about matching the features of the devices that are currently on the market, and trying to make it so that this new device overcomes the issues that the other devices face,” says Fedullo.



## Inspiring Future Engineers

Fedullo is leveraging her training as an engineer and expertise in 3D printing to accelerate HOLLO Medical's product development. Although she only graduated last year, she says she left Dalhousie feeling confident in her abilities as an engineer, an innovator and an entrepreneur.

“I knew from the start that engineering would help me grasp how to create this device and how to make it functional,” she says. “With my chemical engineering degree, I understand at the microscopic



how the medication should travel inside the device. David also has a mechanical engineering degree, so he was quite confident designing and prototyping initial concepts."

When she moved from Italy to Canada to pursue a degree at Dalhousie University, Fedullo says she didn't fully understand the correlation between a degree in engineering and its universal application.

"But I knew that engineering was a broad word for a specialty that applies to everything, from the medical field, to the food processing and automotive industries. Anything that has to do with making something work requires an engineer. "Because we are in so many fields, it's hard to pinpoint exactly what an engineer does because we do everything."

In addition to launching a successful start-up company and designing a device that could help millions of people who suffer from asthma and other respiratory illnesses, Fedullo hopes to inspire other women in STEM who sometimes struggle to find their path within the industry, especially those hoping to pursue their entrepreneurial goals.

"We can talk about how great our solution (HOLLO Medical) is going to be and all of the things that we've accomplished, but at the end of the day what's most important to me is to show people that this is possible," says Fedullo. "Our goal at HOLLO is to help bring this solution to people in need, but one of my personal goals is to inspire women in STEM."

In just over a year, HOLLO Medical has expanded their team three-fold, won the Ready2Launch People's Choice award, secured a place in the Volta Cohort, Innovacorp Accelerate, the ideaHUB BUILD program and Bridge Residency, and are well on their way to bringing this solution to the pockets of those in need.



# ACCELERATING LEADERSHIP IN THE EMERA IDEA HUB

Emera  
ideaHUB

## WITH A FORWARD-THINKING

approach aimed at helping future leaders recognize opportunities and embrace challenges, Erin O’Keefe Graham has a clear vision for Dalhousie’s Emera ideaHUB.

Recently appointed the Director of the HUB, Graham has fostered partnerships and introduced programs designed to help aspiring entrepreneurs thrive in today’s economy.

“Our vision is to be the leading tough

tech incubator in Canada that has the best equipment and the best expertise on hand to help people build products that matter and impact the world,” she says. “But we’re trying to make sure that while these teams are building these technical products, they’re also learning to become better leaders, building stronger teams and building viable businesses.”

Graham’s vision stems from three main pillars of success:

## 1. BUILDING INNOVATION AND ENTREPRENEURSHIP SKILLSET:

“Learn the skillset to build a financially viable venture and a collaborative team. We partner with Dal Innovates and MIT (Martin Center for Entrepreneurship) to help our technical founders build the business skillset and entrepreneurial mindset to build a financially viable venture and a collaborative team.”

## 2. SOLVING COMPLEX PROBLEMS FUELED BY INDUSTRY INPUTS:

“In partnership with select industry advisors, collaborate on customer research to yield rich innovation opportunities. Founders will develop solutions with greater precision thanks to new customer data and industry insight to impact our communities, society and the world.”

## 3. BUILDING LEADERSHIP CAPACITY:

“Uniquely developed for “makers”, leadership development happens through an iterative habit-design process while actively working in team settings. When participants link new behaviours to positive outcomes, they develop new habits and learn that they can adapt change. This means really understanding what it means to develop as a leader and working in a team setting.”







Within the Emera IdeaHUB, Graham says their culture and success are strongly influenced by diversity, inclusivity and equity. Her team has been working to instill an inclusive mindset that allows students, innovators and company founders to view the world with a wider lens.

"We think inclusion has to happen from the very beginning" she says. "If we want to enable early stage product innovation and be a tough tech leader, the ambition that we have here is beyond the product, it's into educating engineers to be inclusive, values-led-leaders."

A generous \$10 million donation from Emera led to the creation of the Emera ideaHUB in 2018. In only a few short years, the Emera ideaHUB has helped 54-start-ups create 106 new jobs and secure \$28 million dollars in funding. The research and new technology born at the Emera ideaHUB has put Atlantic Canada on the map for innovation globally, and a key part of that success is attributed to the opportunities available to students and future founders to explore their innovative and entrepreneurial spirits.

## INDUSTRY SPOTLIGHT:

### THE NEWEST RESIDENT IN THE

Emera ideaHUB is catching a lot of attention.

Combining sustainability and innovation, Katchi Tech is developing a smart fishing net using technologies to improve the efficiency of conventional bottom trawling fishing while also reducing its footprint on the ocean floor.

Bottom trawling is a method of fishing where heavy nets are dragged along the seabed to catch large quantities of fish. In doing so, everything along the ocean floor that happens to be in the way, including all forms of marine life, are swept up into these nets.

While working for his family's fishing company in Yarmouth, Nova Scotia, Marc d'Entremont couldn't help but wonder if there was a better way to execute their fishing activities.

"I started to notice that industry and DFO (Department of Fisheries and Oceans) were always butting heads," he says. "Industry wants to be profitable and DFO wants to save the environment. At some point we needed everyone on the same path and the only way to do that was to get a new fishing method that could adapt to the environmental challenges that we were facing."

In 2019 d'Entremont founded Katchi Tech and is now working on a net that uses hydrodynamic blocks on the top and bottom of the net to ensure that it remains open while in the water, and doesn't touch the ocean floor. The technology replaces existing trawl doors and reduces fuel emissions and greenhouse gases.

"What we're doing is measuring how high the net is off the seabed, measuring cable payout, taking lots of sounds from the GPS vessel, and plugging it all into our algorithm which keeps track of where that boat is," he explains. "As the boat is pushing the net through the water, it measures what's on the seabed from the vessel. If it sees a certain structure, it automatically adjusts the net to avoid that structure."

d'Entremont says his team is



also working on technology that will use lights and bioacoustics to help fisherman efficiently capture their target species while also reducing by-catch. Within the industry, by-catch refers to marine life that is unintentionally caught in a fisherman's net.

"Because the net can move up and down the water column, we can target the species based on where they are in the water column," he says.

Joining the Emera ideaHUB in February, d'Entremont and his team have begun utilizing 3D printing equipment to develop the sensors and electronics required in building their SmartNet.

"For a startup like us, having access to that equipment is huge because it's a cost that we don't need to incur. It helps you build your prototypes and build your proof of concepts, and that's a big struggle for startups," he says. "At the ideaHUB, you have the right people and you have all of the equipment to build what you need."

In September, d'Entremont is hoping to have his full-scale net ready for sea trial. His team will board the Scotia Harvest trawler Léry Charles, and will test their net's control system to see how it performs in real-world conditions.

"We're going to follow another trawler with traditional gear, he's going to make a pass somewhere and we're going to go to the same spot and see what we catch."

# EMERA IDEAHUB START-UP GOES CLEAN AND GREEN

“NO OTHER E-BIKE COMPANY HAS ACCESS TO SUCH TECHNOLOGY. WE WANT TO BE THE FIRST ONES TO COMMERCIALIZE IT WITH OUR E-BIKES AND SHOW THE WORLD WHAT IS POSSIBLE.”

— RAVI KEMPAIAH

**THIS YEAR, 30 MILLION E-BIKES** will be sold around the world. At first glance, those figures may seem like an environmental sustainability success story, but there is a catch: by 2025, the lithium-ion batteries powering those bikes will need to be recycled.

“That waste and the price are the main pain points associated with e-bikes,” says Ravi Kempaiah, a propulsion engineer who is completing a post-doctorate with the Jeff Dahn Research Group at Dalhousie University. “I was thinking about how to address these issues, which led me to Dr. Dahn, who is the leading researcher in lithium-ion battery technology. I shared my ideas for a new company that could resolve those pain points and he said, ‘come to Halifax and I’ll support you.’”

Kempaiah is the co-founder of Zen e-bikes, a new company in the Dalhousie Emera ideaHUB. The company is dedicated to producing high-quality, net-zero alternatives for urban transportation and energy storage products using cutting-edge battery technologies. Its first two e-bikes will launch this year: the mass market Shakti and the premium Samurai. Kempaiah believes the pricing for the Shakti will help break down the

barrier for people to make the shift to more environmentally friendly modes of transportation. But it is the battery technology developed by Dr. Dahn’s team that may prove to be the true game changer for the industry.

“What we have found is that even after 1,000 hours, the battery still has 92 percent capacity,” Kempaiah says. “That means that, after 10 to 12 years of riding, it will still have 90 percent capacity, which will significantly reduce waste and enhance sustainability. No other e-bike company has access to such technology. We want to be the first ones to commercialize it with our e-bikes and show the world what is possible.”

There are other notable advances in design and engineering that set Zen’s e-bikes apart from their competitors. The drive system uses a high-resolution torque sensor instead of a cadence sensor, resulting in a smoother ride that almost feels bionic. The motor has a quick release system that enables it to be unlocked with one hand. And the Samurai swaps out the standard chain for a more durable carbon fibre belt.

“With the belt, you can use the Samurai all year long, even in winter conditions such as slush and road







salt without any real impact to the system," Kempaiah says. "It really is low maintenance and very well suited to North America's climate."

Based on these advantages, Kempaiah is hopeful that more North Americans will invest in e-bikes both to reduce their carbon footprint and for their health. Each year, he notes, Canada spends billions on hip and knee replacements, and much of that could be eliminated if more people commit to 20 minutes of exercise each day.

"Once we have the scale, we will be exploring the benefits of e-bikes through a pilot study with Dalhousie Medical School," he says. "If the data shows that you can gain three to four years of extra life from investing \$3,000 to \$4,000 in a bike, that's an easy decision to make."

The company will begin fulfilling pre-orders for its bikes later this year. Kempaiah has ambitious plans for growth, including cargo bikes, which could significantly reduce last-mile delivery costs for organizations such as FedEx and Canada Post, and other transportation modalities once the company's battery and motor technologies are perfected.

"We hope to achieve that over the next two to three years," he says. "Once the technologies are mature, that will enable us to enter tangential markets such as electric boats and snowmobiles. The possibilities are endless."

◀ *Kady Leard and Ravi Kempaiah, members of Zen-e-bikes*





# DALHOUSIE ALUMNA HELPS IMPROVE HEALTHCARE IN AFRICA

## BAI BINTOU KAIRA (BENG'18)

didn't always know that she wanted to study engineering, but her plans for medical school changed when she started university in Canada. After transferring to Dalhousie University from studying microbiology and immunology in Africa, she was looking for advice on what to study when friends and family suggested she apply to engineering.

At first, she was hesitant, but the consensus of those around her was that she could do anything with a degree in engineering. That decision resulted in lifelong friends, new skills, and the launchpad for Kaira's career.

Combining her interest in medicine and engineering Kaira co-founded GAPhealth Technologies Inc, a company focused on using technology to solve health challenges in Africa.

Finding that phones were the most accessible tool for individuals in the area, Kaira and the GAPhealth team based their technology in the mobile space. Special considerations were implemented to tailor the technology to the realities of the region and to ensure a very user-friendly experience.

The mobile application hosts telemedicine and electronic health records for users. There is also a provider portal that gives the medical provider access to telemedicine. This gives them the ability to prescribe medicine to patients and view medical records. Additionally, the patient portal acts as a comprehensive care medical app where

you can book appointments with your providers, whether virtual, in person, or over text. Users can also set personal medication reminders.

This is a personal area for Kaira, who before her mother's passing took on the role of a care supporter in tracking the medical information and medicines associated with her mother's diabetes.

"The whole point of this app is to give patients the ability to own their health. They can share all, or parts of their records with any provider in the network," she says. This is a task that is a common accessibility barrier between providers.

Another barrier that GAPhealth helps overcome is support for people who may not want to go to the hospital. The app now provides them with an alternative for getting quality care within their community. "Increasing accessibility of care makes a tremendous impact," says Kaira. "We know once people are healthy that has a ripple effect on their kids, their families, and their economic gaining power. We think about health and have a holistic approach to care."

"Long term, we are trying to solve the biases in health."

In addition to GAPhealth, Kaira works full-time with a potash mining company in Saskatchewan where she uses technology to improve operations. She does this all while completing her MBA at the University of Saskatchewan.

In reflecting on what features contribute to the next generation of

working engineers, Kaira says "I think the modern engineer is a better representation of our community. I think people should be able to Google an engineer and find variations; ones that look like them, ones doing different things. It's also having a way of connecting to those people."

"I think it is difficult to be what you can't see," she says on the value that comes from having visible differences represented in the industry. Further to that, Kaira says it's important that people or communities that are experiencing a problem are also a part of creating the solution.

"A modern engineer is someone that defines their path; whether on the road less travelled or sometimes there's no trail at all." Kaira believes it would be a person who lifts as they climb, pulling from a quote from Mary Church Terrell, a well-known Black American activist. "It should always be easier for the next person. We all have a voice, and the ability to help and provide opportunities to help others."

Kaira has an exciting year ahead, with GAPhealth expanding in Ghana and then Gambia. She says she's excited to share the app with the world.

"Our hope is that GAPhealth and healthcare is accessible to people. Quality healthcare is a right. People should not have to choose between going to work and seeing a provider. Opportunities should not be limited based on where you live."

# THE ENTREPRENEURSHIP JOURNEY

## ANDRÉS COLLART (BENG'14, MASC'16)

is a Dalhousie engineering alumnus and entrepreneur. He is also the co-founder and CEO of Trip Ninja, a travel technology company.

His time at Dalhousie not only introduced him to the world of Startups and their ecosystems, it also introduced him to two very important people: his wife and the co-founder of his company.

When undergraduate convocation rolled around, Collart saw many of his classmates considering trips to Europe. He noticed that most people didn't care about the order of the places they visited, they just wanted to choose where they went. This was where the idea for Trip Ninja began. Collart realized he could find a solution to the issue from an engineering perspective.

He and co-founder Brett Zeigler (BEng'14) figured out how to optimize the best order of flights for the cheapest price: "It used to take seven and a half minutes to run the whole program, now it takes 20 seconds."

Beyond the engineering, Collart had to immerse himself into learning the industry, especially how flights were commercialized. He soon realized that in addition to optimizing the order of flights they could also improve the issue of "split ticketing." Their solution ended up having a broader impact than the original idea, with over 42,000 travellers using their technology.

"This has been interesting to go through," says Collart, "you think that

this is the problem that you're out to solve. You solve that and then they're like, Oh no, I'd like you to solve a slightly simpler problem because we can use that more broadly."

## GROWING, CHANGING, AND RESPONDING

"We originally developed the technology during evenings and weekends, starting in 2014. And then, I think it was 2017, I quit my job. Shortly thereafter, Brett quit his job. We started raising some capital, put together a small team, and we've grown since then... until the pandemic," says Collart when reflecting on the company's path.

The travel industry was acutely impacted by the pandemic: "95% of travel was gone, almost overnight" he adds.

Trip Ninja entered the pandemic with around ten employees. "It was tough to be able to navigate that. With the burden of 'I've hired these people and I'm responsible for them.'" With this challenge, Collart worked hard to retain his staff, "I didn't want to lay off my staff due to the pandemic. We were able to keep them employed throughout the pandemic."

It was during the pandemic that Trip Ninja was acquired by WebJet. In rising and responding to this challenge, Collart says, "I'm proud of being able to retain the people that we hired and being able to figure out a path forward that didn't involve mass layoffs."



Through the acquisition of Trip Ninja, Collart has stayed on with the company as CEO. Together with co-founder Brett Zeigler, they continue to move Trip Ninja forward: "We are continuing to grow quite rapidly again. Right now, we have five or six open job postings."

## FROM ADVICE GIVEN TO ADVICE-GIVING

With this leadership role in a growing company, Collart enjoys empowering others to build great products.

For people considering entrepreneurship, Collart's advice is to look at what options you have available. "There's the 'standard' path around, going off and getting a job and having a great career on that front. Then there's starting a business and doing that full-time. But in the middle, there's a whole gradient of possibilities that you can do as well. So, it's not binary."

Collart is a big believer of going all-in for something you are passionate about, whether or not it's from the moment that you have the idea.

# ENGINEERING CAPSTONE TEAMS TAKE ACTION

**WHEN DALHOUSIE MECHANICAL** engineering student Liam Maaskant co-founded Axtion Independence Mobility with business savvy partner Tracey McGillivray, his career path took a new turn.

Once a former defencemen with the Ontario Hockey League and former Captain of the Acadia Axeman hockey team, Maaskant never imagined he'd one day launch an up-and-coming medical device start-up company. But while completing the first two years of his engineering degree at Acadia University, he received a phone call from McGillivray whom he'd previously met through Acadia's Athletics Program. She wanted to discuss the design of a mobility device that would allow her father to live more independently. Although her father already used a walker, he had been experiencing regular falls at home, and wasn't able to get back up on his own or with assistance from her mother.

Now, two years later, Axtion is set to revolutionize the rollator walker so that it can better help its users in the prevention and recovery of falls.

Headquartered in Dalhousie's Emera IDEAhub, the company has teamed up with experts at the Hub to design a mobility device that combines a four-wheeled rollator walker with a mechanical seat to help those who have fallen get back up on their own with minimal assistance. They've also teamed up with Occupational Therapist and Dalhousie alum, Suling Duong, who opened their eyes to new possibilities for the device.

"She really paved the way for what our device could do and all of the features it could help with," says Maaskant. "I came in and I was really focused on just getting a seat that lifts. I didn't see all of the constraints that it had to meet. So for example, lowering the seat flush with the ground."

"Our design started as a fall recovery device and then moved into something that could support users in their daily activities," he adds. "So users transferring themselves on and off a couch or a bed for example. Then lifting themselves back up to a position that is much easier to stand from."

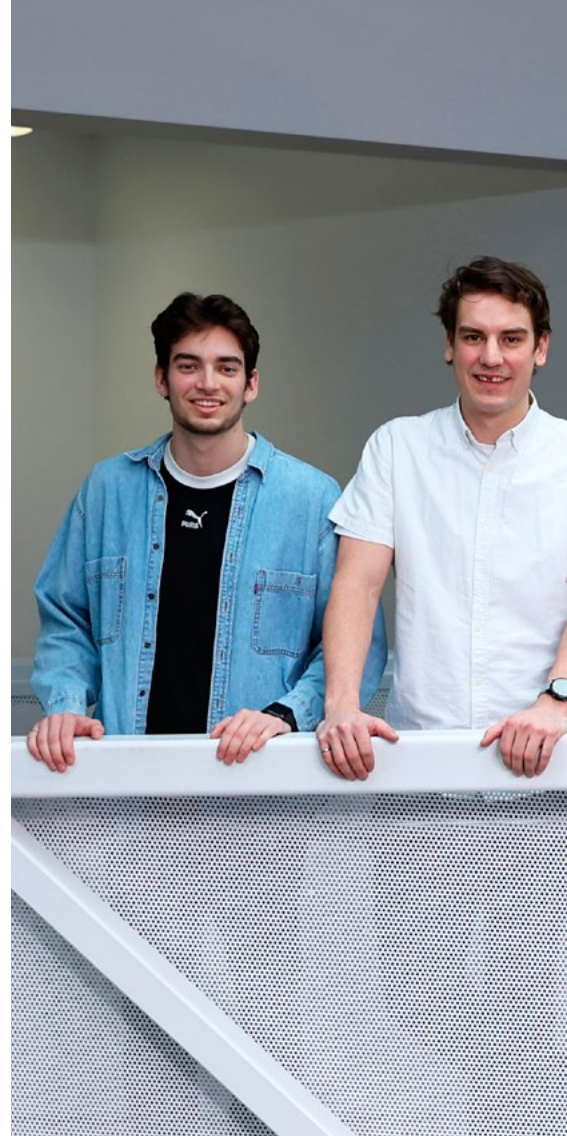
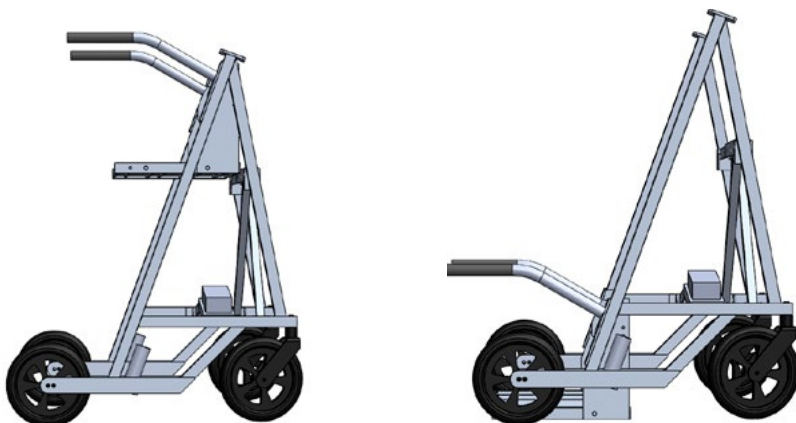

## Capstone Collaborations

These new possibilities meant new opportunities for two groups of Dal engineering students working on their senior year Capstone projects.

Each year, Dalhousie's Capstone program matches engineering student teams with industry partners to design innovative solutions to real-world challenges. Their projects typically involve open-ended problems that companies may not have the resources or expertise to tackle alone.

Maaskant, who is a senior mechanical engineering student himself was also required to complete his Capstone project.





▲ From left to right: Adam Dorrance, Liam Maaskant (me), Matt Ingham, Will Houser, Ben Abraham, Danielle Dey, Lara Mullally, Aya Ghalib

As co-founders of Axtion, he and McGillivray saw the Capstone program as an opportunity to partner with students and gain a fresh perspective on the design of their device. With the goal of completing their prototype for testing by this summer, Maaskant says the device's braking system and a strong, foldable seat for the lift still needed to be designed. So, they teamed up with two student groups from the mechanical engineering program to work on each component of the project. One of those Capstone teams included Maaskant's group. He, along with his three teammates, Matt Ingham, Will Houser, and Adam Dorrance, were tasked with building the device's braking system.

"For me, I love working with my peers. I guess it's very valuable to me. Going through school you learn a lot from class lectures, but you also learn from your study groups and meeting up with your peers," he says. "Matt, Will and Adam

have really come on board and taken control," he adds. "They're the brains of the operation, so I learned a lot from them and from their concepts. I was ecstatic with how much input they had and how much value they added to the product."

At the same time, Danielle Dey and her teammates, who include Aya Ghalib, Lara Mullally and Ben Abraham were responsible for designing a mechanical seat for the rollator walker. Taking into account a list of general requirements including building a foldable product that can also support the full weight of its users as it lifts up and down, Dey says both Maaskant and McGillivray have given their team the freedom and confidence to experiment with their design.

"The seat had to be able to fold in two directions, so it folds for storage and it flips up and out of the way for the user to stand in the centre for added

support," she says. "He (Maaskant) has taken a backseat in terms of directing us and he lets us have the freedom to really make big changes as opposed to having a specific direction they want us to go in."

With the device's brakes and seat now ready for action, Maaskant says it's been a unique experience working as both an industry partner in the Capstone program, and a member of one of the student teams.

"I'm part of the team and I never really wanted to be the boss. All of those guys have done a really great job and are doing things that I probably wouldn't have thought of or wouldn't have been able to do originally," he says. "For us we couldn't have been happier."

# Advancing the Role of Biomedical Engineering in Nova Scotia

## DR. JANIE ASTEPHEN WILSON

is helping Nova Scotia Health develop and oversee a world class research program around its first orthopaedic surgical robot.

Appointed the Director of Dalhousie's School of Biomedical Engineering last September, Wilson is among a team of researchers at the QEII Health Sciences Centre who will utilize the Mako SmartRobotics system to inform and improve patient care.

Only the second of its kind in Canada, the innovative robotic arm assists doctors in joint replacement surgery. The robot's first use in Canada was at St. Joseph's Hospital in Hamilton, Ontario where Wilson was collaborating with the orthopaedic team in developing research and clinical protocols while working as a Professor of Surgery at McMaster University.

Now back in Nova Scotia, Wilson says residents requiring partial or total knee replacements may be offered an option for robotic surgery. The technology will increase the precision and success rate of these surgeries by assisting doctors in more accurately mapping out surgical areas using a 3D Cat scan.

Already leaders in orthopaedic technologies, Wilson and her team have long been using research tools such as instrumented gait analysis, high precision image processing, and data mapping and analytics to study the orthopedic patient population. Although still in the research phase of its development, she says the groundwork for using cutting-edge technologies such as a surgical robot to offer patient-specific surgery has already been laid in Nova Scotia.

"What we've found in studying the biomechanics of patients and failure of implants after surgery is that there are patient factors that affect these outcomes that we can study and model in greater detail. And we can use innovative approaches to understanding the complex differences between

patients," she says. "The robotics system is a new innovation that we're adding to this space that provides us with a significant ability to tailor surgeries that are specific to a person's anatomy and biomechanics."

## ENHANCING PATIENT CARE THROUGH COMMUNITY PARTNERSHIPS

While at McMaster University, Wilson worked with surgeons to develop a world class research program around orthopedic robotics. The program focused on the country's first Mako Robot.

Wilson is now bringing that research to Dal's School of Biomedical Engineering. As Director of the school, she says these types of programs play a significant role in attracting new students to their program and training the next generation of biomedical engineers. But they also play an equally vital role in broadening Dal's future collaborations with health authorities and industry partners within the Halifax community.

"We want to continue to support growth of the biomedical sector in Nova Scotia which is now a well-established and growing enterprise, and the School of Biomedical Engineering has a significant role to play in supporting this industry," she says. "Part of what I'm interested in as a biomedical engineer is how we augment the health care system with innovation and technology to support things such as patient selection and triage, preparing for surgery and developing clinical monitoring and rehabilitation programs with wearable technologies and outpatient assessments."

Wilson adds that the current work under way with the Mako Robot will lay the foundation for future projects within the province by helping researchers understand how to tailor patient care based on a person's needs and response to surgical procedures.

"Once we know this, we can come up with interesting technology-driven solutions for optimizing patients before surgery and during surgery. And optimizing the surgery itself to suit the needs of the individual. And then implement a technology and data driven approach to monitoring clinical outcomes."





# Centre of Success



## IN 2019, THE MELDA MURRAY

Student Centre opened its doors to engineering students across Sexton Campus, and significantly reduced many of the barriers previously encountered by students when trying to access university supports and services on Dal's Studley campus.

Today the Centre is dedicated to supporting undergraduate and graduate students with tailored and accessible programming, appointments and services designed to meet their needs, enhance their student experience, and contribute to improving their academic wellbeing.

Here's a look at the impact The Melda Murray Centre has had on engineering students since its opening.

### List of Supports and Services:

- Graduate Student Engagement Coordinator/Peer Advisor
- MMSC International Student Peer Advisor
- Wellness Challenges throughout each semester
- Career Workshops
- Evening and weekend career support and study space
- MMSC Mental Health Promotion Coordinator position.

### Statistics:

**118** FACILITATED EVENTS

**373** STUDENTS PROVIDED WITH CAREER APPOINTMENTS

**201** STUDENTS HELPED WITH STUDY SKILLS

**6** NEW STUDENT POSITIONS DEVELOPED ON CAMPUS (1 FULL TIME POSITION)

# Honouring Student Leaders

## TANAKA AKIYAMA IS A FIRM

believer that "anything is possible;" at least when it comes to efficient time management.

Despite a full course load, the fourth year electrical engineering student still finds a few extra hours in her week to co-chair Dalhousie's IEEE (Institute of Electrical and Electronic Engineers) Student Branch, participate on the Faculty of Engineering's Microtransat Autonomous Sailboat team, build a satellite with the Dalhousie Space System Labs (DSS), and launch the Faculty of Engineering's first Autonomous Underwater Vehicle Society.

"You just have to really manage your time, learn to give priority to your different tasks and change the priorities as necessary," she says.

A former varsity soccer player with the Saint Mary's Huskies, Akiyama says she learned early on in her academic career how to prioritize her activities. After completing the first two years of her engineering degree at SMU, she came to Dal looking for a challenge and looking to get more involved with her new community.

"The reason why I'm a part of so many things is because everything is so interesting and I don't want to miss out on anything," she says. And it's rewarding to see that something you have created has helped other students become successful."

She says this especially includes her work as co-chair of IEEE, a student led organization that helps electrical engineering students bridge the gap between academia and industry.

"We put on events and workshops that help students advance their professional skills and technical skills. These are events that help them make the transition into industry," she says. "And when students are hired at these events, even if it's just one or two, it makes all the difference."

For her leadership and community



contributions, Akiyama was recently named to the Faculty of Engineering's Dean's Leadership list. Each year, the Faculty honours undergraduate students for their achievements beyond the classroom.

Congratulations to all of this year's recipients:

- Tanaka Akiyama
- Laara Banks
- Bhavneet Bhatia
- Sophia Briskin
- Shivam Chauhan
- Emily Chisholm
- Alex Cross
- Noah D'Ascanio
- Hayden Ehler
- Jade Farr
- Lachlan Greechan
- Nashita Jalal
- Mohammad Johar
- Vinayak Maheshwari
- Lara Mullally
- Alexis Mulligan
- Natasha Rowan Pratt
- Sarah van den Heuvel
- Maddie Whitehouse
- Lauren Williams





**1.** The Covid-19 pandemic has re-shaped the way we teach and learn. In the Fall of 2021, Dalhousie University Civil Engineering Professor Dr. Craig Lake introduced a new model of innovative teaching to his students called the “flipped classroom.”

Drawing on components of traditional based learning, the model allows students to learn new materials at home, and then discuss or practice those concepts in the classroom. Each week Dr. Lake provides filmed lecture and lab videos for his students to watch online prior to class. Following each video,

students were then given a short quiz to assess their level of understanding. While in the classroom, Dr. Lake then focused his time and attention on engaging students, asking questions, and ensuring they better understood the materials they had learned at home.



**2.** Dr. Robert Adamson from Dalhousie's School of Biomedical Engineering has received funding from the Canadian Institutes of Health Research (CIHR) for research that'll soon make inner ear surgery possible with new imaging technology.

Precise diagnosis of middle ear diseases can be difficult as physicians are unable to see beyond the eardrum to assess problems with structures behind it. Dr. Adamson has developed a new imaging technology that allows for a view through the eardrum and the ability to measure vibrations of middle ear structures. This innovation allows for higher resolution and higher contrast images than competing technologies. He and his team are now exploring how this new technology can be used to diagnose a variety of different middle ear diseases to help ear surgeons better plan surgeries and counsel patients.

**3.** Dalhousie Engineering Professor Dr. Graham Gagnon was awarded the Albert E. Berry Medal for his significant contributions to the field of Environmental Engineering. Dr. Gagnon, who is the NSERC Halifax water Senior Industrial Chair in Water Quality and Treatment and the Director of the Centre for Water Resources Studies, has gained international recognition over the years for his research in water quality and treatment and its vast impact on the health and safety of people all over the world.



**4.** Dr. Amina Stoddart, Assistant Professor and Dr. Graham Gagnon in Dalhousie's Department of Civil and Resource Engineering, are leveraging a state-of-the-art passive sampling approach to monitor cyanobacteria in lakes across Nova Scotia. The team has been awarded funding by Research Nova Scotia and Genome Atlantic to analyze harmful algal blooms that produce cyanobacteria. As a result of climate change, these bacteria have begun to turn up more frequently in lakes, and under certain circumstances they can release toxins and compounds that affect water quality.

**5.** Dalhousie's Faculty of Engineering Industrial professor Dr. Noreen Kamal has been recognized by the Royal Society of Canada (RSC) for her outstanding scholarly and scientific achievements. Dr. Kamal is a recognized leader in improving processes to ensure timely treatment of stroke patients. Her work has significantly improved health outcomes. Dr. Kamal has applied her Industrial Engineering expertise to improving health systems so that stroke patients receive better care as it relates to hospital arrival times, diagnosis and treatment.





# A Dalhousie Alum's Incredible Legacy on Engineering Education



**WITHIN THE ENGINEERING COMMUNITY, PEARL SULLIVAN (BENG'85, MASC'86)**

was a true gem. She was the first woman in Canada to become Dean of Engineering at the University of Waterloo, and only the fourth

woman in Canada to head a school of engineering at the time.

Throughout her career she was a champion in the area of disruptive technologies, a dynamic leader and a respected researcher. In October of 2021, she was named one of the top 100 most powerful women in the country by Women's Executive Network (WXN). But, to her husband Tom Sullivan and her children, she was much more than her enormous legacy.

"It wasn't just engineering that made her great. She went into engineering because she wanted to help people and solve problems," says Tom. "But it was her love for students that really defined her. Everything she did was for the students. Every decision she made, was for her students."

Pearl passed away last November after a twelve-year battle with cancer.

Born in Malaysia, the Dalhousie Engineering alum immigrated to Canada in the 1980s to pursue a degree in Metallurgical Engineering at the Technical University of Nova Scotia (now Dalhousie University). It was there she met her husband, Tom.

"She kept sitting in my seat at the back of our Industrial Engineering course, and I kept asking, are you staying in that seat?," says Tom. "She had come to class two weeks late because she was finishing a co-op at General Motors and they gave her a plaque signed by Wayne Gretzky because she had the best co-op project of the year."

Although small in stature, Pearl was fierce and mighty with the ability to do anything she set her mind to. Her passion for education and desire to inspire the next generation of future engineers led her to a career in academia. In 1994, she joined the mechanical engineering department at the University of New Brunswick where she was honoured twice with the UNB Faculty of Merit Award for Excellence. Then in 2004, she was hired by the University of Waterloo as a mechanical engineering professor, later serving as chair of the department.

Highly respected and admired by her students, peers and colleagues, Tom says Pearl was approached several times to become Dean of the Faculty of Engineering but was hesitant to accept.

"Then there was a moment when Pearl and I were holding each other, and the doctor had given her some pretty bad news. Pearl started talking again about being Dean, and I asked her if she'd like to do it, and she said 'yes, I would. I would feel like I did something and accomplished something'"

In 2012, Pearl became the Dean of Engineering at the University of Waterloo. Despite her battle with cancer, she focused tirelessly on her students.

She envisioned the future of engineering education in a way no one else had ever done. She forged strong relationships with government and industry partners such as Research in Motion and introduced new programs and research opportunities to the Faculty in the areas of robotics and wireless communications, advanced manufacturing, artificial intelligence and nanotechnologies. She helped the Faculty of engineering put up five new student spaces on campus and launched a student campaign aimed at ensuring that they had the resources and support to achieve their individual goals.

"She did more in a day than I would do in a year," says Tom. "Once you had her support on something, you knew that it was going to be a success."

"But she did it for the students. She wanted these engineers to be people who cared. She often said to her students, 'we can teach you the engineering. You're smart enough to be in engineering. The challenge is for you to be a human being. You need to learn how to care and love and follow your passion'"

At heart, Pearl was a student herself, full of energy and life. Often times she could be found engaging with her students on campus, smile on her face and words of wisdom to share. Tom says she loved her students as if they were her own children.

"Pearl was fearless but made people feel relaxed when she was with them. They gravitated towards her because she was fun to be around. But her strength and fortitude came from her love for students. She always focused on making it fun and she put the fun in fundraising."



▲ **Outstanding Recognition:** For a third straight year, the Faculty of Engineering's ACI (American Concrete Institute) Student Chapter has secured the ACI Outstanding University Award. The ACI Foundation promotes progress, innovation and collaboration in the concrete industry through programs and scholarships. The foundation gives student chapters the opportunity to apply classroom theory and project management skills to real concrete projects.



▲ **Women in STEM Panel.** In November, 2021, Dalhousie's Faculties of Engineering, Computer Science, and Science hosted the 4th annual Women in STEM Networking event. Three women from a wide variety of STEM related fields shared their perspectives on the challenges and opportunities of being a woman in STEM. Representing the field of Engineering was Dal alumna Anne-Marie Colbert (BEng '89), the Director of Personnel (Human Resources) for Michelin North America (Canada).

**Engineering Impact: Water and Indigenous Communities.** In March, 2022, the Faculty of Engineering hosted a live virtual panel to explore solutions for Indigenous communities struggling to access clean water. Panelists included, Ryan Dunbar, president of SOAR Professional Services; Carl Yates, interim CEO of the Atlantic First Nations Water Authority Inc. (AFNWA); Tiannic Paul, an operations engineer with AFNWA; and Julie DiCicco, an environmental engineer with Dillon Consulting. The group discussed how engineers can improve aging water infrastructures on reserves, and the importance of "two-eyed seeing" and community representation when designing solutions.

**Beijing Olympics 2022.** Congratulations to engineering graduate Mike Evelyn (BEng '19) who had the opportunity to participate in the 2022 Winter Olympics on the Canadian National Bobsleigh team. During his time at Dalhousie University, Evelyn played on the Dalhousie Tigers Hockey team. Before graduating with his engineering degree, he attended the RBC Training Ground event in 2018. The event helps identify athletes with Olympic potential. Evelyn's exceptional abilities caught the attention of the Canadian National Bobsleigh Team, and they recruited him to the team in 2019.



▲ **Making an Impact.** Congratulations to engineering students, Jesse Li and Vinayak Maheshwari who each received a 2022 IMPACT award for student leadership, and to the Faculty of Engineering's IEEE Student Chapter who won the President's Equity, Diversity, Inclusion & Accessibility Award. The IMPACT awards celebrate the accomplishments of Dalhousie students on and off campus.

**12th Annual Engineering Golf Tournament.** After a year's pause due to the COVID-19 pandemic, we welcomed back alumni, friends and community partners to a day of fun and fundraising in October 2021. The event raised more than \$14,000 towards the Student Experience Fund which enables engineering student to participate in experiential learning opportunities throughout the year.



▲ **Engineering student Emma Leeshanok** has been named one of Dalhousie University's 2021 Top Co-op Students of the Year. Working for various co-op employers such as Irving Consumer Products, Leeshanok says the co-op program has had a significant impact on her personal development and the type of career she hopes to pursue.





**EMERGENCY  
MICROBURSARIES**

**YOU CAN MAKE SURE  
HELP IS AVAILABLE WHEN  
IT REALLY MATTERS**

**Things don't always go as planned.** Unexpected financial challenges are the number one factor influencing university students' ability to stay in school and pursue their ambitions. In these moments, a little help goes a long way.

An **Emergency Microbursary** could be what keeps someone on track to graduate. Your gift, no matter the size, can make that difference.

Help students stay the course. Give today at [giving.dal.ca/micro](https://giving.dal.ca/micro)



DALHOUSIE  
UNIVERSITY



DALHOUSIE  
UNIVERSITY

FACULTY OF ENGINEERING

Return undeliverable Canadian addresses to:  
Alumni & Donor Relations Office  
Faculty of Engineering  
Suite 108, Morroy Building, 5269 Morris Street  
PO Box 15000  
Halifax NS B3H 4R2

CANADA		POSTES
POST		CANADA
Postage paid		Port payé
Publications Mail		Poste-publications
40065040		